

## ZF 10 M

Vertical offset, direct mount marine transmission.

### Maximum Input\*\*

Duty	kW	hp	RPM
Pleasure	38	50	5000
Light	34	45	5000
Medium	32	42	5000
Continuous	28	37	5000

\*\* Must not be exceeded

## Description

- Reverse reduction marine transmission with mechanically actuated multi-disc clutches .
- Suitable for high performance applications in luxury sailboats, motoryachts, fishing boats, etc. .
- Robust design also withstands continuous duty in workboat applications .
- Fully works tested, reliable and simple to install .
- Design, manufacture and quality control standards comply with ISO 9001 .

## Features

- Lightweight and robust aluminum alloy casing (sea water resistant) .
- Case hardened and precisely ground gear teeth for long life and smooth running .
- Output shaft thrust bearing designed to take maximum propeller thrust .
- Compact, space saving design .

## Options

- Engine-matched torsional coupling .
- BW, SAE 4, SAE 5 and SAE 6 bell housings .
- Oil cooler. To be used when input power exceeds following values: - Pos. «A» not required - Pos. «B» 25kW .
- Control cable bracket for mounting of push-pull cable to the control lever .
- Classification by all major Classification Societies on request .

# ZF 10 M

## Ratings

### Pleasure Duty

	RATIOS		MAX. TORQUE		POWER/RPM		MAXIMUM RATED POWER						MAX. RPM
	'A' Pos	'B' Pos	Nm	ftlb	kW	hp	2800 rpm		3000 rpm		3600 rpm		
							kW	hp	kW	hp	kW	hp	
<span style="color: red;">■</span>	2.045	1.864	91	67	0.0095	0.0128	27	36	29	38	34	46	5000
<span style="color: blue;">■</span>	2.722	2.150	65	48	0.0068	0.0091	19	26	20	27	25	33	5000

Max input power 34 kW

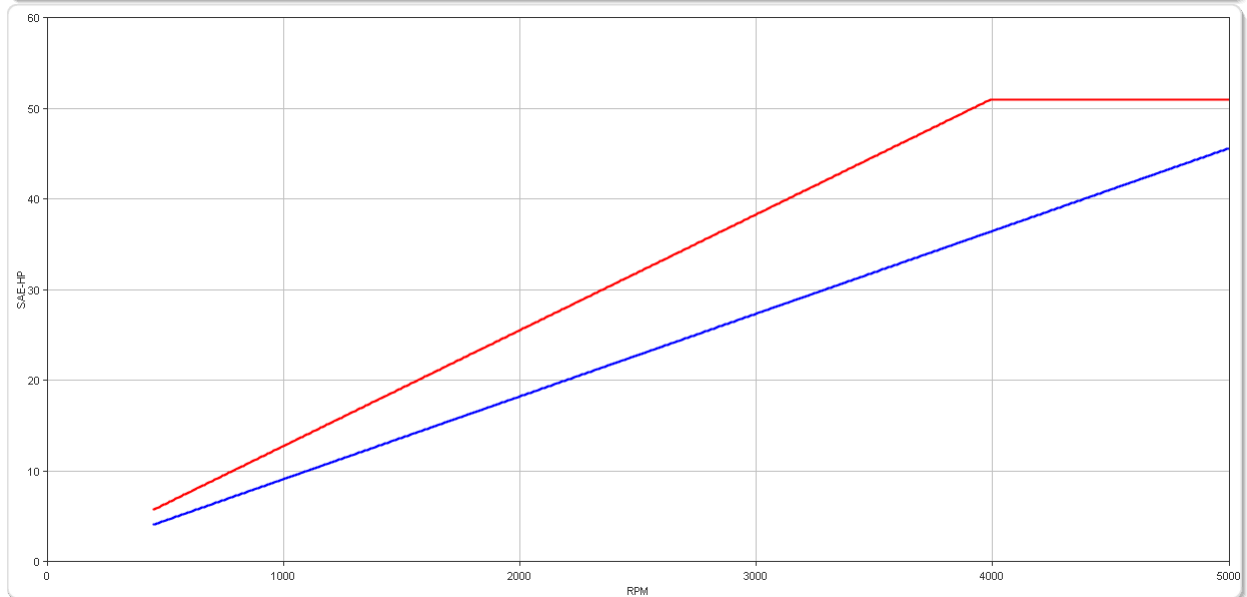
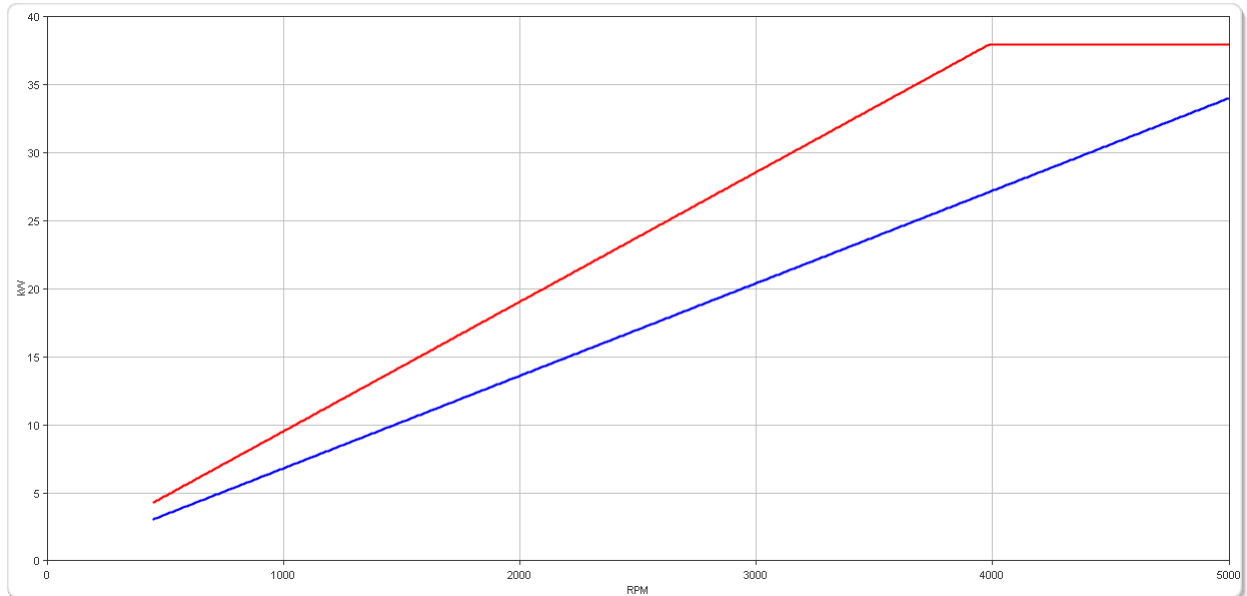

"A" POS = continuous running position (normally AHEAD). "B" POS = reverse position. B/W = Borg Warner adaptor.  
 Note: For all "M" (Mechanical) transmissions reduce power capacity by the following shock factors:  
 1 cylinder engine ÷ 1.25, 2 cylinder engine ÷ 1.20, 3 cylinder engine ÷ 1.15

# ZF 10 M

## Ratings

### Light Duty

	RATIOS		MAX. TORQUE		POWER/RPM		MAXIMUM RATED POWER						MAX. RPM
	'A' Pos	'B' Pos	Nm	ftlb	kW	hp	2800 rpm		3000 rpm		3600 rpm		
							kW	hp	kW	hp	kW	hp	
<span style="color: red;">■</span>	2.045	1.864	82	60	0.0086	0.0115	24	32	26	35	31	41	5000
<span style="color: blue;">■</span>	2.722	2.150	58	43	0.0061	0.0081	17	23	18	24	22	29	5000

Max input power 32 kW

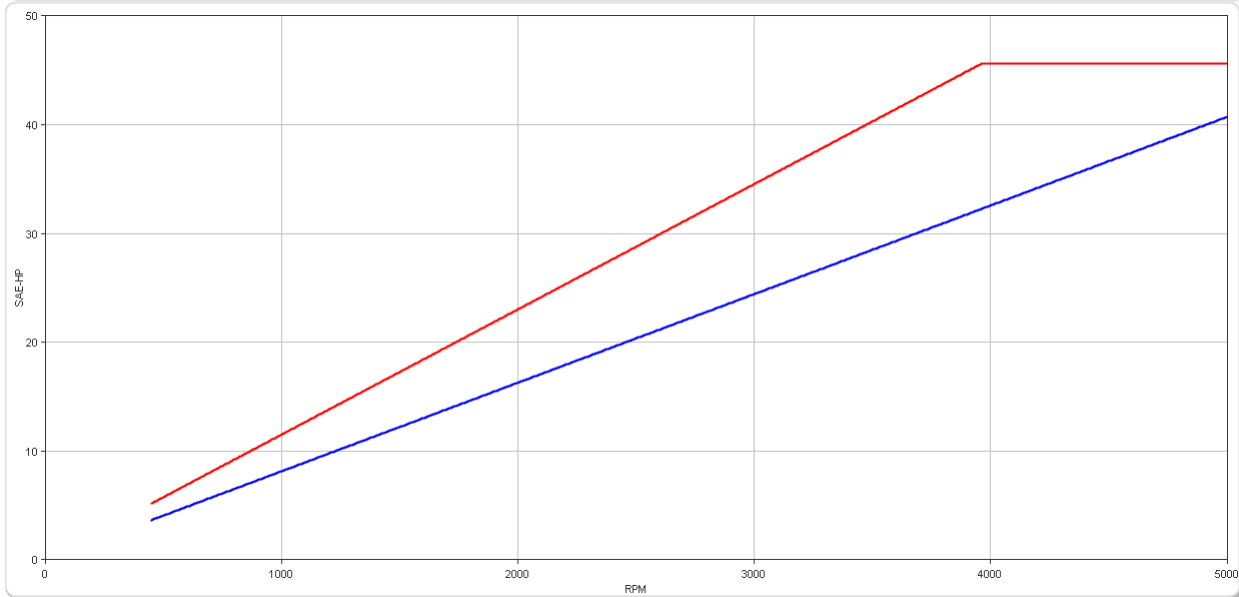
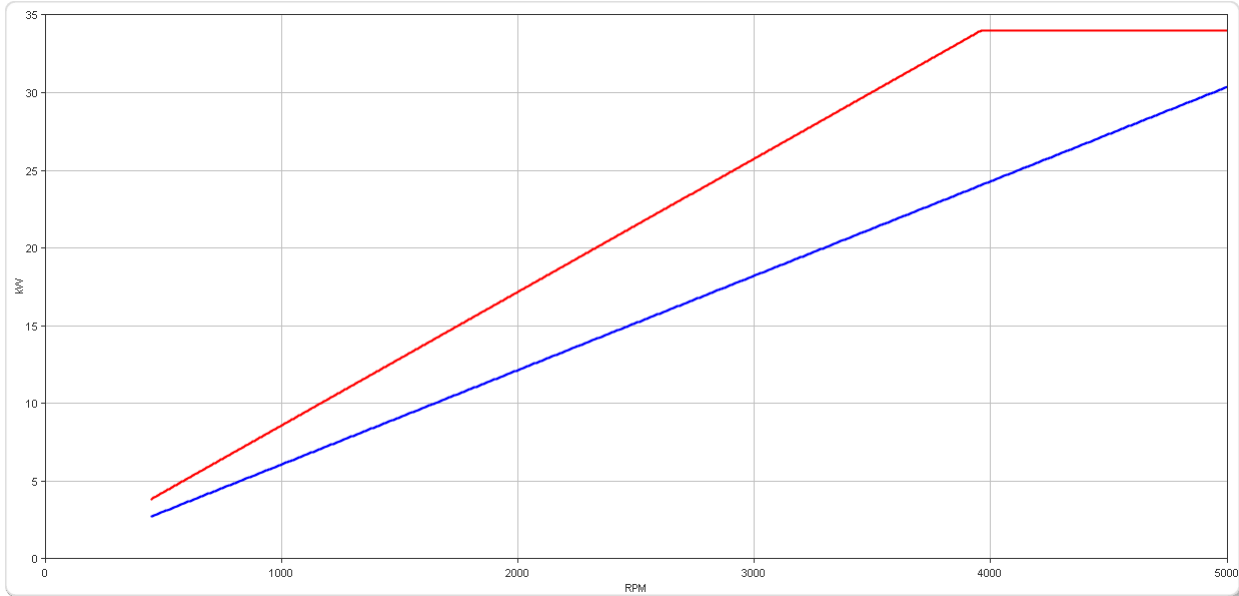

"A" POS = continuous running position (normally AHEAD). "B" POS = reverse position. B/W = Borg Warner adaptor.  
 Note: For all "M" (Mechanical) transmissions reduce power capacity by the following shock factors:  
 1 cylinder engine ÷ 1.25, 2 cylinder engine ÷ 1.20, 3 cylinder engine ÷ 1.15

# ZF 10 M

## Ratings

### Medium Duty

	RATIOS		MAX. TORQUE		POWER/RPM		MAXIMUM RATED POWER						MAX. RPM
	'A' Pos	'B' Pos	Nm	ftlb	kW	hp	2100 rpm		2500 rpm		2800 rpm		
							kW	hp	kW	hp	kW	hp	
<span style="color: red;">■</span>	2.045	1.864	77	57	0.0081	0.0108	17	23	20	27	23	30	5000
<span style="color: blue;">■</span>	2.722	2.150	56	41	0.0059	0.0079	12	17	15	20	16	22	5000

Max input power 28 kW

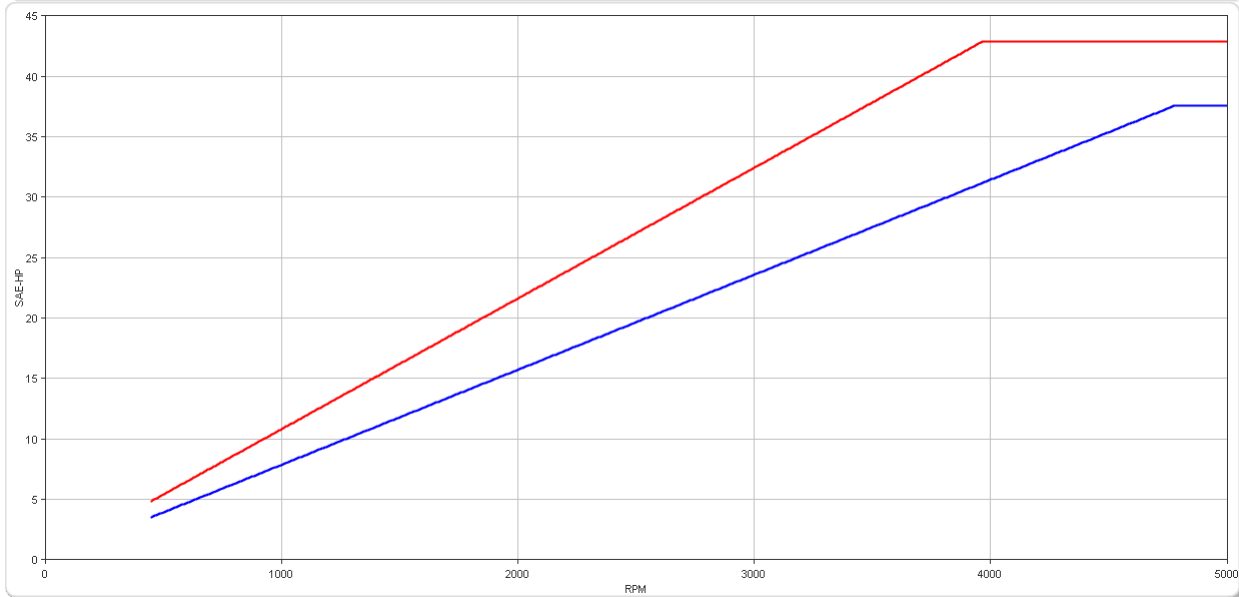
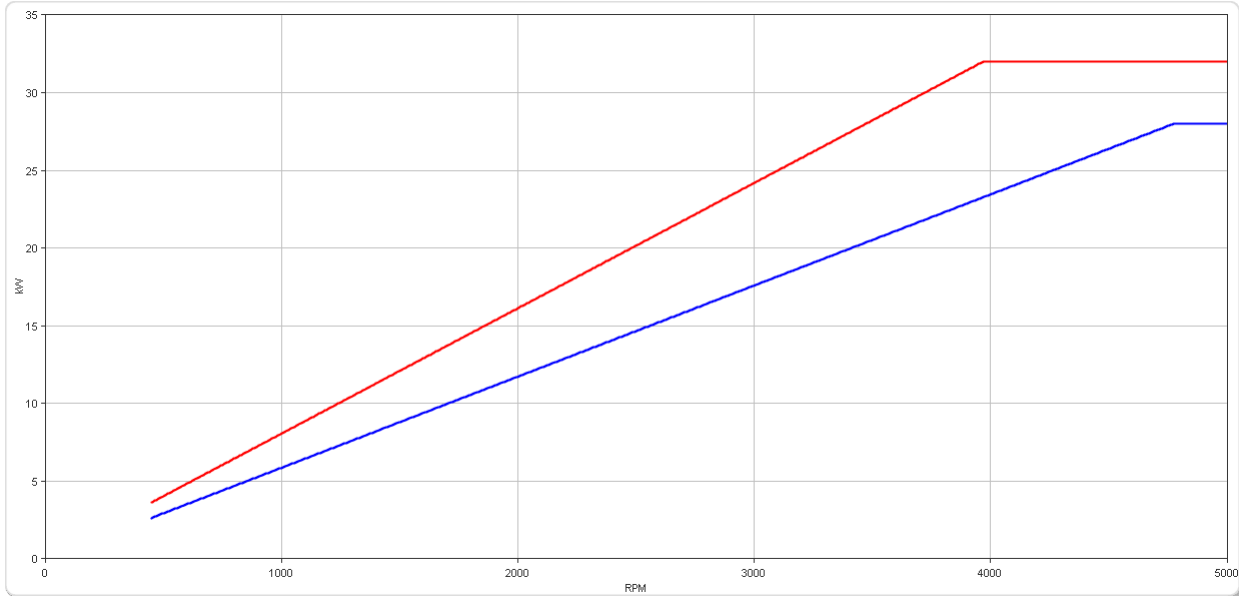

"A" POS = continuous running position (normally AHEAD). "B" POS = reverse position. B/W = Borg Warner adaptor.  
 Note: For all "M" (Mechanical) transmissions reduce power capacity by the following shock factors:  
 1 cylinder engine ÷ 1.25, 2 cylinder engine ÷ 1.20, 3 cylinder engine ÷ 1.15

# ZF 10 M

## Ratings

### Continuous Duty

	RATIOS		MAX. TORQUE		POWER/RPM		MAXIMUM RATED POWER						MAX. RPM
	'A' Pos	'B' Pos	Nm	ftlb	kW	hp	1800 rpm		2300 rpm		2600 rpm		
							kW	hp	kW	hp	kW	hp	
<span style="color: red;">■</span>	2.045	1.864	75	55	0.0079	0.0105	14	19	18	24	20	27	5000
<span style="color: blue;">■</span>	2.722	2.150	54	40	0.0057	0.0076	10	14	13	17	15	20	5000

Max input power 25 kW

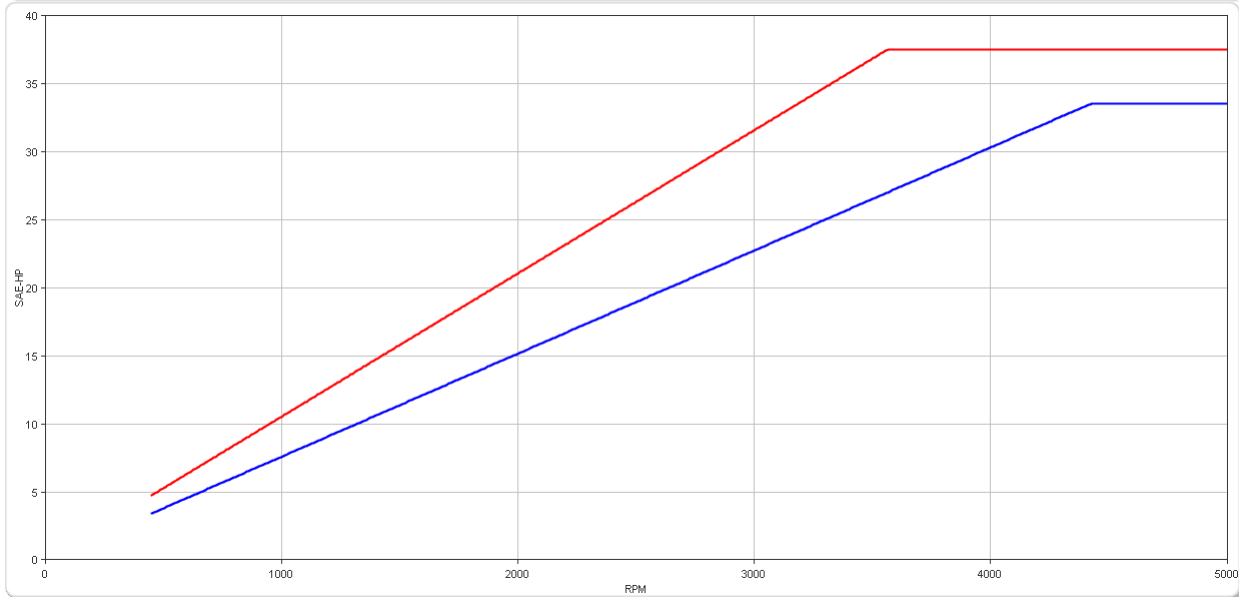
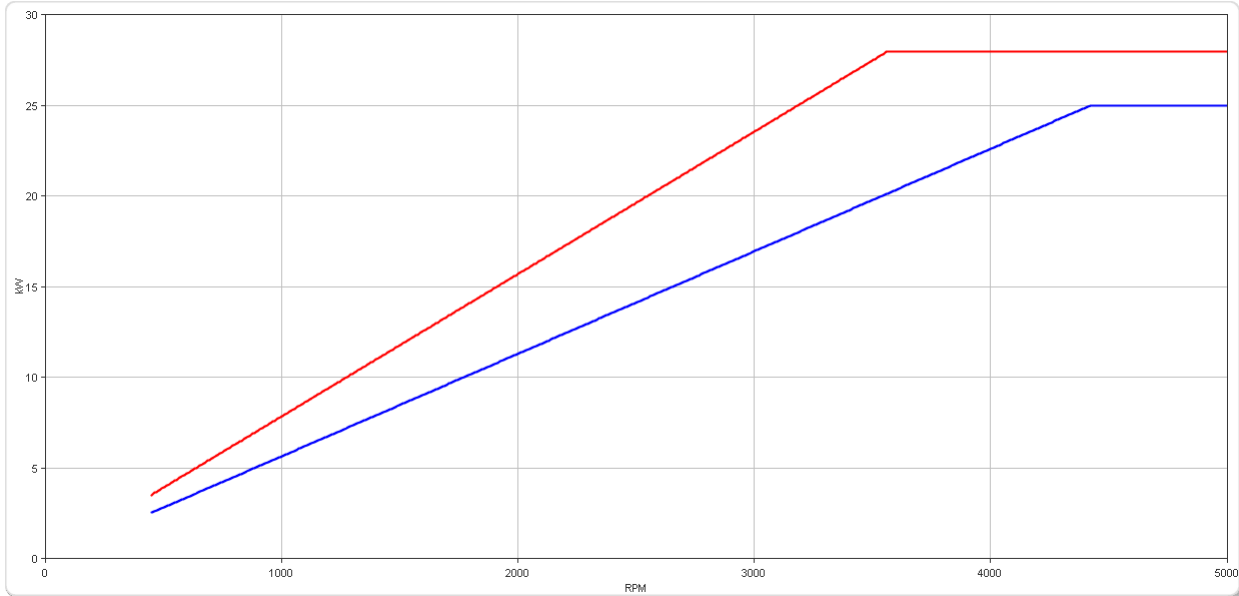

"A" POS = continuous running position (normally AHEAD). "B" POS = reverse position. B/W = Borg Warner adaptor.  
 Note: For all "M" (Mechanical) transmissions reduce power capacity by the following shock factors:  
 1 cylinder engine ÷ 1.25, 2 cylinder engine ÷ 1.20, 3 cylinder engine ÷ 1.15

# ZF 10 M

## Dimensions

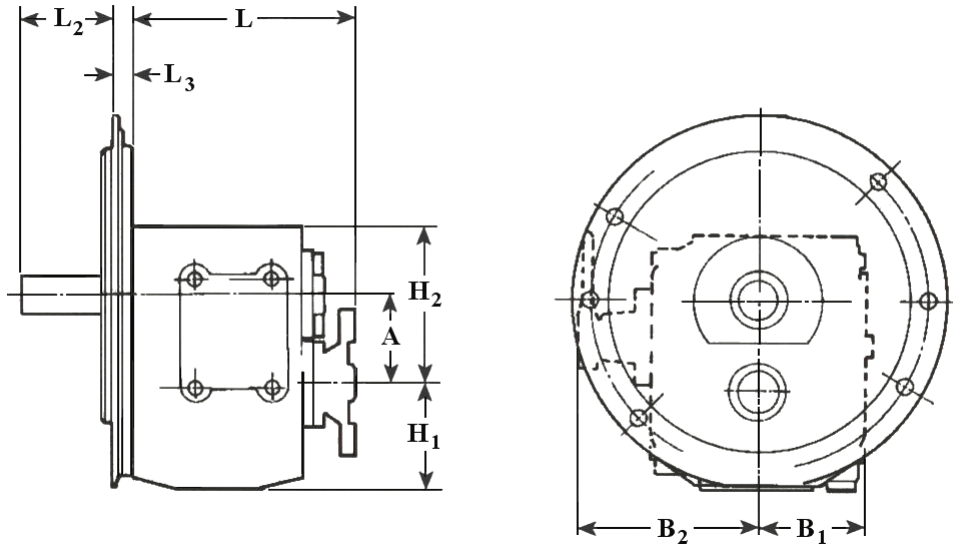

mm (inches)									
A	B <sub>1</sub>	B <sub>2</sub>	C	H <sub>1</sub>	H <sub>2</sub>	L	L <sub>2</sub>	L <sub>3</sub>	Bell Hsg.
62.0 (2.44)	75.0 (2.95)	128 (5.04)	-	110 (4.33)	73.0 (2.87)	180 (7.09)	60.0 (2.36)	15.0 (0.59)	B/W
Weight kg (lb)					Oil Capacity Litre (US qt)				
10.3 (23.0)					0.42 (0.45)				

### SAE Bell Housing Dimensions

SAE No.	A		B		C		Bolt Holes		
	mm	in	mm	in	mm	in	No.	Diameter	
4	361.95	14.25	381.0	15.0	403.23	15.875	12	10.32	13/32

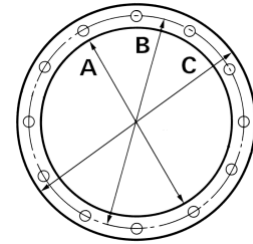

### Output Coupling Dimensions

A		B		C		D		Bolt Holes		
mm	in	mm	in	mm	in	mm	in	No.	Diameter (E)	
102	4.02	82.5	3.25	63.5	2.50	10.0	0.39	4	10.5	0.41

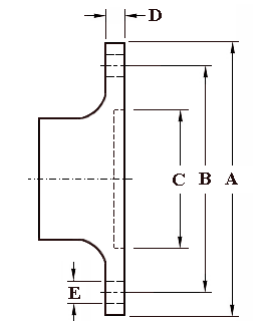

## Duty Definitions

<b>PLEASURE DUTY DEFINITION</b>	Highly intermittent operation with very large variations in engine speed and power
Average engine operating hours limit:	500 hours/year 300 hours/year for mechanical gearboxes
Typical hull forms:	Planing.
Typical applications:	Private, non-commercial, non-charter sport/leisure activities.
<b>LIGHT DUTY DEFINITION</b>	Intermittent operation with large variations in engine speed and power
Average engine operating hours limit:	2500 hours/year (for hydraulic gearboxes smaller than the ZF 650 series, 2000 hours/year).
Typical hull forms:	Planing and semi-displacement.
Typical applications:	Private and charter, sport/leisure activities, naval and police activities.
<b>MEDIUM DUTY DEFINITION</b>	Intermittent operation with some variations in engine speed and power
Average engine operating hours limit:	4000 hours/year. 3500 hours/year for gearboxes smaller than ZF 2000 series and workboat ZF W2700 series.
Typical hull forms:	Semi-displacement and displacement
Typical applications:	Charter and commercial craft (example: crew boats and fast ferries), and naval and police activities.
<b>CONTINUOUS DUTY DEFINITION</b>	Continuous operation with little or no variations in engine speed and power
Average engine operating hours limit:	Unlimited
Typical hull forms:	Displacement.
Typical applications:	Heavy duty commercial vessels, tugs, fishing boats.

## Duty Ratings

Ratings apply to marine diesel engines at the indicated speeds. At other engine speeds, the respective power capacity (kW) of the transmission can be obtained by multiplying the Power/Speed ratio by the speed.

Approximate conversion factors:

1 kW = 1.36 metric hp

1 kW = 1.34 U.S. hp (SAE)

1 U.S. hp = 1.014 metric hp

1 Nm = 0.74 lb.ft.

Ratings apply to right hand turning engines, i.e. engines having counterclockwise rotating flywheels when viewing the flywheel end of the engine. These ratings allow full power through forward and reverse gear trains, unless otherwise stated.

Contact your nearest ZF Sales and Service office for ratings applicable to gas turbines, gasoline (petrol) engines, as well as left hand turning engines, and marine transmissions for large horsepower capacity engines.

Ratings apply to marine transmissions currently in production or in development and are subject to change without prior notice.

**NOTE:** THE MAXIMUM RATED INPUT POWER MUST NOT BE EXCEEDED (SEE RESPECTIVE RATINGS IN THE TECHNICAL DATA SHEETS)

## Safe Operating Notice

The safe operation of ZF products depends upon adherence to technical data presented in our brochures. Safe operation also depends upon proper installation, operation and routine maintenance and inspection under prevailing conditions and recommendations set forth by ZF. Damage to transmission caused by repeated or continuous emergency manoeuvres or abnormal operation is not covered under warranty. It is the responsibility of users and not ZF to provide and install guards and safety devices, which may be required by recognized safety standards of the respective country (e.g. for U.S.A. the Occupational Safety Act of 1970 and its subsequent provisions).

## Monitoring Notice

The safe operation of ZF products depends upon adherence to ZF monitoring recommendations presented in our operating manuals, etc. It is the responsibility of users and not ZF to provide and install monitoring devices and safety interlock systems as may be deemed prudent by ZF. Consult ZF for details and recommendations.

## Torsional Responsibility and Torsional Couplings

The responsibility for ensuring torsional compatibility rests with the assembler of the drive and driven equipment. ZF can accept no liability for gearbox noise caused by vibrations or for damage to the gearbox, the flexible coupling or to other parts of the drive unit caused by this kind of vibration. Contact ZF for further information and assistance. ZF recommends the use of a torsional limit stop for single engine powered boats, wherein loss of propulsion power can result in loss of control. It is the buyer's responsibility to specify this option, which can result in additional cost and a possible increase in installation length.

ZF can accept no liability for personal injury, loss of life, or damage or loss of property due to the failure of the buyer to specify a torsional limit stop. ZF selects torsional couplings on the basis of nominal input torque ratings and commonly accepted rated engine governed speeds. Consult ZF for details concerning speed limits of standard offering torsional couplings, which can be less than the transmission limit. Special torsional couplings may be required for Survey Society Ice Classification requirements.

